

Microwave oven

User manual

MS32J5133B*/MS40J5133B*



SAMSUNG

Contents

Using this user manual	3	Operations	13
The following symbols are used in this User Manual:	3	Feature panel	13
Safety instructions	3	Simple steps to start	13
Important safety instructions	3	Manual mode	14
Installation	7	Common settings	14
What's included	7	Sensor cook	15
Installation site	8	Auto cook	16
Turntable	8	Convenience	20
Maintenance	9	Keep warm	24
Cleaning	9	Steam clean	25
Replacement (repair)	9	Cooking Smart	26
Care against an extended period of disuse	9	Microwave cooking guide	26
Before you start	10	Reheating guide	28
Current time	10	Defrosting guide	29
Power saving	10	Quick & Easy	30
Child Lock	10	Troubleshooting and information code	31
Sound On/Off	11	Troubleshooting	31
Kitchen timer	11	Information codes	33
About microwave energy	11	Technical specifications	34
Cookware for microwave	12		

Using this user manual

You have just purchased a SAMSUNG microwave oven. Your Owner's Instructions contains valuable information on cooking with your microwave oven:

- Safety precautions
- Suitable accessories and cookware
- Useful cooking tips
- Cooking tips

The following symbols are used in this User Manual:

WARNING

Hazards or unsafe practices that may result in **severe personal injury or death**.

CAUTION

Hazards or unsafe practices that may result in **minor personal injury or property damage**.

NOTE

Useful tips, recommendations, or information that helps users manipulate the product.

Safety instructions

IMPORTANT SAFETY INSTRUCTIONS

READ CAREFULLY AND KEEP FOR FUTURE REFERENCE.

MICROWAVE FUNCTION ONLY

WARNING: If the door or door seals are damaged, the oven must not be operated until it has been repaired by a competent person.

WARNING: It is hazardous for anyone other than a competent person to carry out any service or repair operation that involves the removal of a cover which gives protection against exposure to microwave energy.

WARNING: Liquids and other foods must not be heated in sealed containers since they are liable to explode.

WARNING: Only allow children to use the oven without supervision when adequate instructions have been given so that the child is able to use the oven in a safe way and understands the hazards of improper use.

This appliance is intended to be used in household only and it is not intended to be used such as:

- staff kitchen areas in shops, offices and other working environments;
- farm houses;

Safety instructions

- by clients in hotels, motels and other residential environments;
- bed and breakfast type environments.

Only use utensils that are suitable for use in microwave ovens. When heating food in plastic or paper containers, keep an eye on the oven due to the possibility of ignition.

Metallic containers for food and beverages are not allowed during microwave cooking.

The microwave oven is intended for heating food and beverages. Drying of food or clothing and heating of warming pads, slippers, sponges, damp cloth and similar may lead to risk of injury, ignition or fire.

If smoke is observed (emitted), switch off or unplug the appliance and keep the door closed in order to stifle any flames.

Microwave heating of beverages can result in delayed eruptive boiling, therefore care must be taken when handling the container.

The contents of feeding bottles and baby food jars shall be stirred or shaken and the temperature checked before consumption, in order to avoid burns.

Eggs in their shell and whole hard-boiled eggs should not be heated in microwave ovens since they may explode, even after microwave heating has ended.

The oven should be cleaned regularly and any food deposits removed.

Failure to maintain the oven in a clean condition could lead to deterioration of the surface that could adversely affect the life of the appliance and possibly result in a hazardous situation.

The microwave oven is intended to be used on the counter top (freestanding) use only, the microwave oven shall not be placed in a cabinet.

The appliance should not be cleaned with a water jet.

The appliance is not intended for installing in road vehicles, caravans and similar vehicles etc.

This appliance is not intended for use by persons (including children) with reduced physical, sensory or mental capabilities, or lack of experience and knowledge, unless they have been given supervision or instruction concerning use of the appliance by a person responsible for their safety.

Children should be supervised to ensure that they do not play with the appliance.

This appliance can be used by children aged from 8 years and above and persons with reduced physical, sensory or mental capabilities or lack of experience and knowledge if they have been given supervision or instruction concerning use of the appliance in a safe way and understand the hazards involved. Children shall not play with the appliance. Cleaning and user maintenance shall not be made by children without supervision. If the supply cord is damaged, it must be replaced by the manufacturer, its service agent or similarly qualified persons in order to avoid a hazard.

This oven should be positioned proper direction and height permitting easy access to cavity and control area. Before using the your oven first time, oven should be operated with the water during 10 minute and then used. If the oven generates a strange noise, a burning smell, or smoke is emitted, unplug the power plug immediately and contact your nearest service center. The microwave oven has to be positioned so that plug is accessible.

General safety

Any modifications or repairs must be performed by qualified personnel only.

Do not heat food or liquids sealed in containers for the microwave function.

Do not use benzene, thinner, alcohol, or steam or high-pressure cleaners to clean the oven.

Do not install the oven: near a heater or flammable material; locations that are humid, oily, dusty or exposed to direct sunlight or water; or where gas may leak; or an uneven surface.

This oven must be properly grounded in accordance with local and national codes. Regularly use a dry cloth to remove foreign substances from the power plug terminals and contacts.

Do not pull, excessively bend, or place heavy objects on the power cord.

If there is a gas leak (propane, LP, etc) ventilate immediately. Do not touch the power cord.

Do not touch the power cord with wet hands.

While the oven is operating, do not turn it off by unplugging the power cord.

Do not insert fingers or foreign substances. If foreign substances enter the oven, unplug the power cord and contact a local Samsung service centre.

Do not apply excessive pressure or impact to the oven.

Do not place the oven over fragile objects.

Ensure the power voltage, frequency, and current matches the product specifications.

Firmly plug the power plug into the wall socket. Do not use multiple plug adapters, extension cords, or electric transformers.

Do not hook the power cord on metal objects. Make sure the cord is between objects or behind the oven.

Do not use a damaged power plug, power cord, or loose wall socket. For damaged power plugs or cords, contact a local Samsung service centre.

Do not pour or directly spray water onto the oven.

Do not place objects on the oven, inside, or on the oven door.

Do not spray volatile materials such as insecticide on the oven.

Safety instructions

Do not store flammable materials in the oven. Because alcohol vapours can contact hot parts of the oven, use caution when heating food or drinks containing alcohol. Children may bump themselves or catch their fingers on the door. When opening/closing the door, keep children away.

Microwave warning

Microwave heating of beverages may result in delayed eruptive boiling; always use caution when handling the container. Always allow beverages to stand at least 20 seconds before handling. If necessary, stir during heating. Always stir after heating.

In the event of scalding, follow these First Aid instructions:

1. Immerse the scalded area in cold water for at least 10 minutes.
2. Cover with a clean, dry dressing.
3. Do not apply any creams, oils, or lotions.

To avoid damaging the tray or rack, do not put the tray or rack in water shortly after cooking.

Do not use the oven for deep fat frying because the oil temperature cannot be controlled. This could result in a sudden boil over of hot oils.

Microwave oven precautions

Only use microwave-safe utensils. Do not use metallic containers, gold or silver trimmed dinnerware, skewers, etc.

Remove wire twist ties. Electric arcing may occur.

Do not use the oven to dry papers or clothes.

Use shorter times for small amounts of food to prevent overheating or burning.

Keep the power cord and power plug away from water and heat sources.

To avoid the risk of explosion, do not heat eggs with shells or hard-boiled eggs. Do not heat airtight or vacuum-sealed containers, nuts, tomatoes, etc.

Do not cover the ventilation slots with cloth or paper. This is a fire hazard. The oven may overheat and turn off automatically and will remain off until it cools sufficiently.

Always use oven mitts when removing a dish.

Stir liquids halfway during heating or after heating ends and allow the liquid stand at least 20 seconds after heating to prevent eruptive boiling.

Stand at arms length from the oven when opening the door to avoid getting scalded by escaping hot air or steam.

Do not operate the oven when it is empty. The oven will automatically shut down for 30 minutes for safety purposes. We recommend placing a glass of water inside the oven at all times to absorb microwave energy in case the oven is started accidentally.

Install the oven in compliance with the clearances in this manual. (See Installing your microwave oven.)

Use caution when connecting other electrical appliances to sockets near the oven.

Microwave operation precautions

Failure to observe the following safety precautions may result in harmful exposure to microwave energy.

- Do not operate the oven with the door open. Do not tamper with the safety interlocks (door latches). Do not insert anything into the safety interlock holes.
- Do not place any object between the oven door and front face or allow food or cleaner residue to accumulate on sealing surfaces. Keep the door and door sealing surfaces clean by wiping with a damp cloth and then with a soft, dry cloth after each use.
- Do not operate the oven if it is damaged. Only operate after it has been repaired by a qualified technician.
Important: the oven door must close properly. The door must not be bent; the door hinges must not be broken or loose; the door seals and sealing surfaces must not be damaged.
- All adjustments or repairs must be done by a qualified technician.

Limited warranty

Samsung will charge a repair fee for replacing an accessory or repairing a cosmetic defect if the damage to the unit or accessory was caused by the customer. Items this stipulation covers include:

- Door, handles, out-panel, or control panel that are dented, scratched, or broken.
- A broken or missing tray, guide roller, coupler, or wire rack.

Use this oven only for its intended purpose as described in this instruction manual. Warnings and Important Safety Instructions in this manual do not cover all possible conditions and situations that may occur. It is your responsibility to use common sense, caution, and care when installing, maintaining, and operating your oven.

Because these following operating instructions cover various models, the characteristics of your microwave oven may differ slightly from those described in this manual and not all warning signs may be applicable. If you have any questions or concerns, contact a local Samsung service centre or find help and information online at www.samsung.com.

Use this oven for heating food only. It is intended for domestic use only. Do not heat any type of textiles or cushions filled with grains. The manufacturer cannot be held liable for damage caused by improper or incorrect use of the oven.

To avoid deterioration of the oven surface and hazardous situations, always keep the oven clean and well maintained.

Product group definition

This product is a Group 2 Class B ISM equipment. The definition of group 2 which contains all ISM equipment in which radio-frequency energy is intentionally generated and/or used in the form of electromagnetic radiation for the treatment of material, and EDM and arc welding equipment.

For Class B equipment is equipment suitable for use in domestic establishments and in establishments directly connected to a low voltage power supply network which supplies buildings used for domestic purposes.

Installation

What's included

Make sure all parts and accessories are included in the product package. If you have a problem with the oven or accessories, contact a local Samsung customer centre or the retailer.

Oven at a glance

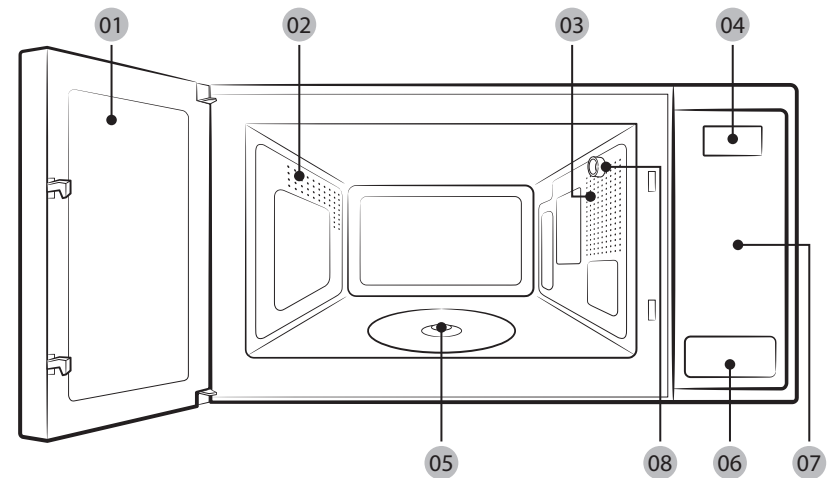

- | | | |
|-------------------------|-----------------------------|-----------------------|
| 01 Door | 02 Vent | 03 Oven light |
| 04 Display | 05 Coupler | 06 Open (door) |
| 07 Feature panel | 08 Water bowl holder | |

Installation

Accessories

The oven comes with different accessories that help you prepare different types of food.



Roller ring

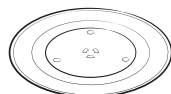

Turntable



Clean water bowl

Roller ring	Put in the centre of the base. It supports the turntable.
Turntable	Put on the roller ring with the centre fitting the coupler. It serves as a cooking base.
Clean water bowl	The water bowl can be used to clean.

NOTE

Do not operate the oven without the turntable on the roller ring.

Installation site

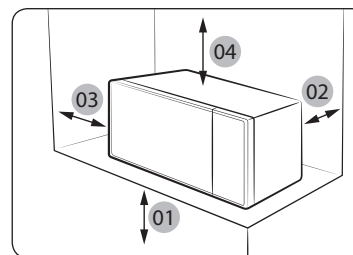

- 01** 85 cm from the floor
- 02** 10 cm from the rear wall
- 03** 10 cm from the side
- 04** 20 cm from above

- Select a flat, level surface approx. 85 cm above the floor. The surface must support the weight of the oven.
- Secure room for ventilation, at least 10 cm from the rear wall and both sides, and 20 cm from above.
- Do not install the oven in hot or damp surroundings, such as next to other microwave ovens or radiators.
- Conform to the power supply specifications of this oven. Use only approved extension cables if you need to use.
- Wipe the interior and the door seal with a damp cloth before using your oven for the first time.

Turntable

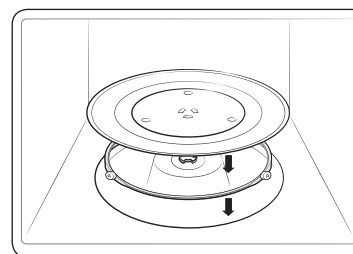

Remove all packing materials inside the oven. Install the roller ring and turntable. Check that the turntable rotates freely.

Maintenance

Cleaning

Clean the oven regularly to prevent impurities from building up on or inside the oven. Also pay special attention to the door, door sealing, and turntable and roller ring (applicable models only).

If the door won't open or close smoothly, first check if the door seals have built up impurities. Use a soft cloth in soapy water to clean both the inner and outer sides of the oven. Rinse and dry well.

To remove stubborn impurities with bad smells from inside the oven

1. With an empty oven, put a cup of diluted lemon juice on the centre of the turntable.
2. Heat the oven for 10 minutes at max power.
3. When the cycle is complete, wait until the oven cools down. Then, open the door and clean the cooking chamber.

To clean inside swing-heater models

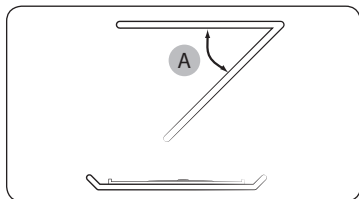

To clean the upper area of the cooking chamber, lower the top heating element by 45° (A) as shown. This will help clean the upper area. When done, reposition the top heating element.

CAUTION

- Keep the door and door sealing clean and ensure the door opens and closes smoothly. Otherwise, the oven's lifecycle may be shortened.
- Take caution not to spill water into the oven vents.
- Do not use any abrasive or chemical substances for cleaning.
- After each use of the oven, use a mild detergent to clean the cooking chamber after waiting for the oven to cool down.

Replacement (repair)

WARNING

This oven has no user-removable parts inside. Do not try to replace or repair the oven yourself.

- If you encounter a problem with hinges, sealing, and/or the door, contact a qualified technician or a local Samsung service centre for technical assistance.
- If you want to replace the light bulb, contact a local Samsung service centre. Do not replace it yourself.
- If you encounter a problem with the outer housing of the oven, first unplug the power cord from the power source, and then contact a local Samsung service centre.

Care against an extended period of disuse

- If you don't use the oven for an extended period of time, unplug the power cord and move the oven to a dry, dust-free location. Dust and moisture that builds up inside the oven may affect the performance of the oven.



Before you start

There is some basic information that you should know before going directly to a cooking recipe. Before or during any cooking mode, you can set/change the clock or the kitchen timer to your needs.

Current time

It is important to set the correct clock time to ensure correct automatic operations. The time can be displayed in either the 24- hour (default) or 12-hour notation. You must set the clock.

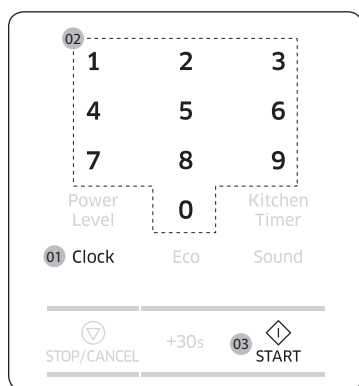

To display the time in the 12-hour / 24-hour notation.

1. Press the **Clock** button and the **0** button at the same time for 1 second.
2. Time setting that you want to change (12Hr or 24Hr) will be displayed.
3. If you want to change the notation again, press the **number** buttons. For example, press 1 for 12Hr or press 2 for 24 Hr notation.
4. Press the **START** button to confirm your setting,

To set the current time,

1. Press **Clock**.
2. Use the number buttons to enter the current time. For example, press 5, 0, and 0 in sequence for 5:00 o'clock.
3. Press **START** to confirm your settings. Then, the colon (:) indicator blinks several times.

Power saving

To reduce power consumption when not using the oven, use the power saving function of the oven.

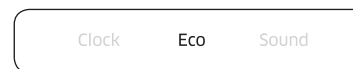

- To activate power saving, press **Eco** to turn off the display.
- To deactivate power saving, open the door or press **Eco** again. The display turns back on with the current time.

Auto power saving

- After 25 minutes of user inactivity, the oven automatically enters power saving mode. Any previous function will be cancelled, and the current time will be displayed.
- After 5 minutes of the door being open, the oven lamp will turn off.

Child Lock



- To prevent accidents, Child Lock disables all controls except for the **Eco** button.
- Press the **STOP/CANCEL** button for 3 seconds to activate, or press the **STOP/CANCEL** button for 3 seconds again to deactivate the lock on the feature panel.



Sound On/Off

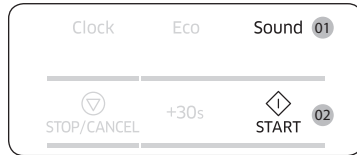

You can mute or unmute the beep or melody of the oven.

- To mute the sound, press **Sound** to show "OFF" on the display. Then, press **START**.
- To unmute the sound, press **Sound** again to show "ON" on the display. Then, press **START**.

Kitchen timer

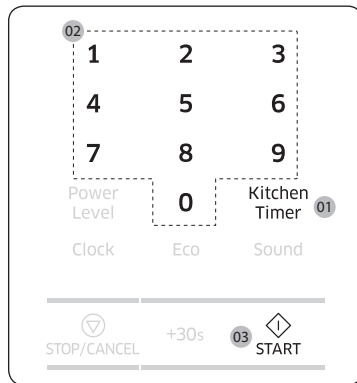

1. Press **Kitchen Timer**.
2. Use the number buttons to set the time for your cooking.
3. Press **START**.

About microwave energy

Microwaves are high-frequency electromagnetic waves. The oven uses the prebuilt magnetron to generate microwaves which are used to cook or reheat food without deforming or discolouring the food.

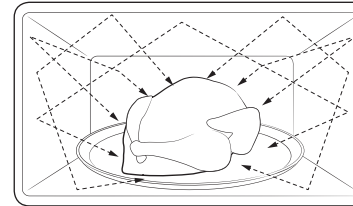

1. The microwaves generated by the magnetron are distributed uniformly through the whirling distribution system. This is why the food is cooked evenly.
2. The microwaves are absorbed down to the food up to a depth of approx. 2.5 cm. Then, the microwaves are dissipated inside the food as cooking continues.
3. The cooking time is affected by the following conditions of the food.
 - Quantity and density
 - Moisture content
 - Initial temperature (especially, when frozen)

NOTE

The cooked food keeps heat in its core after cooking is complete. This is why you must respect the standing time specified in this manual, which ensures cooking evenly down to the core.

Before you start

Cookware for microwave

Cookware used for Microwave Mode must allow microwaves to pass through and penetrate food. Metals such as stainless steel, aluminum and copper reflect microwaves. Therefore, do not use cookware made of metallic materials. Cookware marked microwave - safe is always safe for use. For additional information on appropriate cookware refer to the following guide and place a glass of water or some food on the turntable.

Requirements:

- Flat bottom and straight sides
- Tight-fitting lid
- Well-balanced pan with handles that weigh less than the main pan

Material	Microwave-safe	Description	
Aluminium foil	△	Use for a small serving size to protect against overcooking. Arcing can occur if the foil is near the oven wall or if using an excessive amount of foil.	
Crusty plate	○	Do not use for preheating for more than 8 minutes.	
Bone china or earthenware	○	Porcelain, pottery, glazed earthenware and bone china are usually microwave-safe, unless decorated with a metal trim.	
Disposable polyester cardboard dishes	○	Some frozen foods are packaged in these dishes.	
Fast-food packaging	Polystyrene cups or containers	○	Overheating may cause these to melt.
	Paper bags or newspaper	×	These may catch fire.
	Recycled paper or metal trims	×	These may cause arcing

Material	Microwave-safe	Description	
Glassware	Oven-to-table ware	○	Microwave-safe unless decorated with metal trims.
	Fine glassware	○	Delicate glassware may break or crack by rapid heating.
	Glass jars	○	Appropriate for warming only. Remove the lid before cooking.
Metal	Dishes	×	These may cause arcing or fire.
	Freezer bag with twist-ties	×	
Paper	Plates, cups, napkins, and kitchen paper	○	Use to cook for a short time. These absorb excess moisture.
	Recycled paper	×	Causes arcing.
Plastic	Containers	○	Use thermoplastic containers only. Some plastics may warp or discolour at high temperatures.
	Cling film	○	Use to maintain moisture after cooking.
	Freezer bags	△	Use boilable or ovenproof bags only.
Wax or grease-proof paper	○	Use to maintain moisture and prevent spattering.	

○ : Microwave safe

△ : Use caution

× : Microwave unsafe

Operations

Feature panel

The front panel comes in a wide range of materials and colours. For improved quality, the actual appearance of the oven is subject to change without notice.

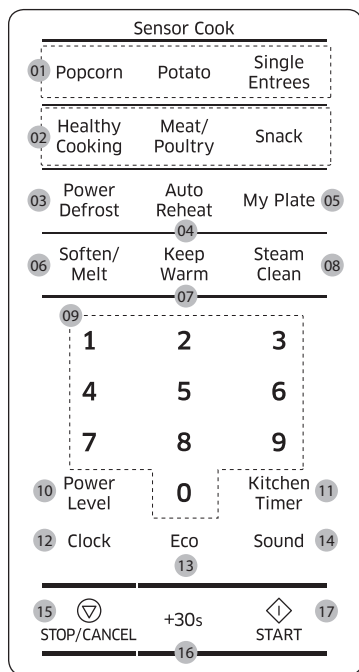

01	Sensor Cook
02	Auto Cook
03	Power Defrost
04	Auto Reheat
05	My Plate
06	Soften/Melt
07	Keep Warm
08	Steam Clean
09	Number pad
10	Power Level
11	Kitchen Timer
12	Clock
13	Eco
14	Sound
15	Stop/Cancel
16	+30s
17	Start

Simple steps to start

To cook food

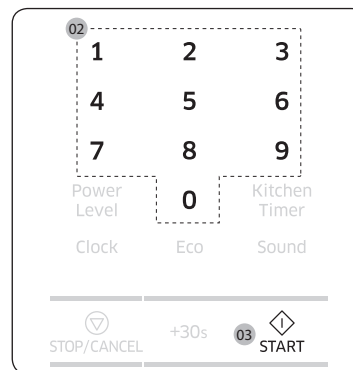

1. Put the food in a microwave-safe container and then in the centre of the turntable.
2. Use the number buttons to set the cooking time.
3. Press **START**.

NOTE

When cooking is complete, the oven beeps 4 times. Use oven gloves to take out the food.

To defrost frozen food

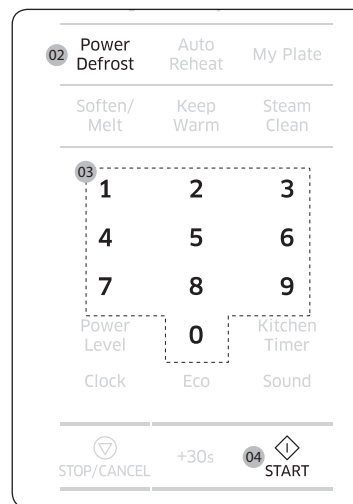

1. Put the frozen food in a microwave-safe container and then in the centre of the turntable.
2. Press **Power Defrost**.
3. Use the number buttons to set the serving size.
4. Press **START**.

NOTE

For more information, see the Power Defrost section.



Operations

Manual mode

Microwave

This is the basic function of this microwave oven. The power level is set to High by default.

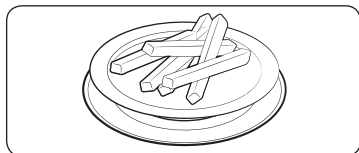

1. Put food in a microwave-safe container and then on the turntable.

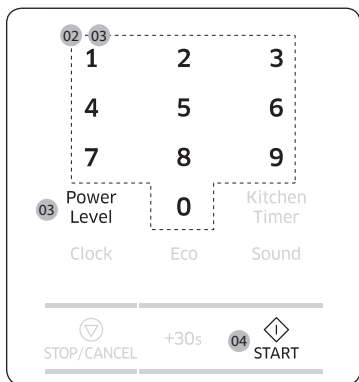

2. Use the number buttons to set the cooking time (max: 99 min 99 sec). For example, press 1 and 0 for the minutes, and 0 and 0 for the seconds (10:00).

3. To change the default power level, press **Power Level** and select a different level. See the **Power level** section for details.

4. Press **START**.

5. When cooking is complete with a beep 4 times, use oven gloves to take out the food.

Common settings

Cooking time

Follow these steps to set or change the cooking time. By default, the power level is set to High.

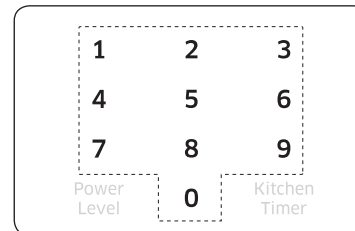

Use the number buttons to set the cooking time (max: 99 min 99 sec). The time area consists of the minute and second elements. To set a cooking time of 25 minutes, for example, press 2 and 5 for the minutes, then 0 and 0 for the seconds.

NOTE

- To change the cooking time during operation, press **STOP/CANCEL**, and repeat the steps above.
- To stop cooking, simply open the door, or press **STOP/CANCEL**. To resume operation, close the door and press Start.
- To cancel cooking, press **STOP/CANCEL** twice.

Time increment

You might want to add extra time to the current cooking time while cooking is in process. Time can be added by 30 seconds.

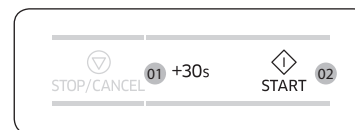

1. Before or during cooking, press **+30s** as many times as needed. For example, to add 2 minutes to the current cooking time, press the button 4 times.
2. Press **START**. The oven continues to operate for the changed time.

NOTE

This button is not enabled with Auto mode.



Power level

You can change the heating intensity according to the cooking recipe or to your preference.

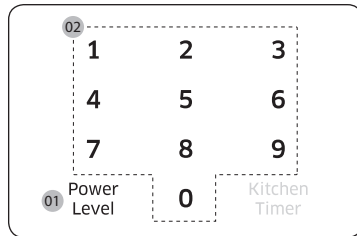

1. Press **Power Level**.
2. Use the number buttons to select a specific power level. Available levels range from No power (0) to High (10). See the table below.

0	PL:0	No power
1	PL:10	Warm
2	PL:20	Defrost
3	PL:30	Low
4	PL:40	Medium low
5	PL:50	Medium
6	PL:60	Simmer
7	PL:70	Medium high
8	PL:80	Reheat
9	PL:90	Sauté
10	PL:Hi	High

NOTE

To check the current power level while cooking is in process, press **Power Level**.

Sensor cook

A sensor in the microwave oven detects moisture released from food as it heats, and adjusts the cooking time accordingly.

Make sure microwave oven has been plugged in for at least 3 minutes. Use microwave-safe dish with loose-fitting lid, or cover microwave-safe dish with plastic wrap, and vent.

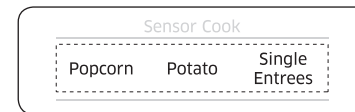

1. Press the **Sensor Cook** button corresponding to the food you are cooking.
2. Press the **START** button (Potato, For example). The display shows "0:30" and your microwave oven will begin cooking. If you want to check the current time while cooking is in progress, press the **Clock** button.

Operations

Sensor cooking guide

Follow the instructions below when sensor cooking different types of food.

Food	Amount
Popcorn	85-100 g 1 package
	Procedure Use only one microwave-only bag of popcorn at a time. Use caution when removing and opening hot bag from oven. Let oven cool for at least 5 minutes before using again.
Potato	1 to 6 ea.
	Procedure Prick each potato several times with fork. Place on turntable in spoke-like fashion. Let stand 3-5 min. Let oven cool for at least 5 minutes before using again.
Single Entress	220-400 g
	Procedure Remove food from outer wrapping and follow box instructions for covering and standing. Let oven cool for at least 5 minutes before using again.

Auto cook

1. Healthy Cooking & 2. Meat/Poultry

For healthier alternatives, the oven offers a total of 16 Healthy Cook programmes in 2 different categories. Take advantage of this feature to save you time or shorten your learning curve. The cooking time and temperature will be adjusted according to the selected recipe.

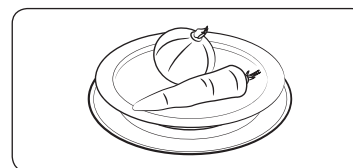

1. Put food in a microwave-safe container and then in the centre of the turntable.

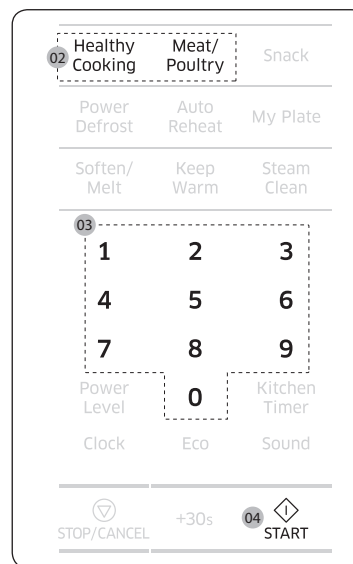

2. Select a category by pressing either **Healthy Cooking** or **Meat/Poultry**.
3. Use the selected button again or the number buttons to select a specific programme.
4. Press **START**.
5. When cooking is complete with a beep 4 times, use oven gloves to take out the food.

Healthy Cook guide

The following table presents auto programmes for cooking, roasting, and baking. The table contains food quantities, weight ranges, and appropriate recommendations. Cooking modes and times have been pre-programmed for your convenience.

1. Healthy Cooking

Code	Food	Serving Size (g)	Instructions
1	Broccoli Florets	250	Rinse and clean fresh broccoli and prepare florets. Put them evenly into a glass bowl with lid. Add 30 ml (2 tbsp) water. Put bowl in the centre of turntable. Cook covered. Stir after cooking. Stand for 1-2 minutes.
2	Carrots	250	Rinse and clean carrots and prepare even slices. Put them evenly into a glass bowl with lid. Add 30 ml (2 tbsp) water. Put bowl in the centre of turntable. Cook covered. Stir after cooking. Stand for 1-2 minutes.
3	Green Beans	250	Rinse and clean green beans. Put them evenly into a glass bowl with lid. Add 30 ml (2 tbsp) water. Put bowl in the centre of turntable. Cook covered. Stir after cooking. Stand for 1-2 minutes.

Code	Food	Serving Size (g)	Instructions
4	Peeled Potatoes	250	Wash and peel the potatoes and cut into a similar size. Put them into a glass bowl with lid. Add 45-60 ml (3-4 tbsp) water. Put bowl in the centre of turntable. Cook covered. Stand for 2-3 minutes.
5	Brown Rice	250	Use a large glass ovenware dish with lid. Add double quantity of cold water (500 ml). Cook covered. Stir before standing time and add salt and herbs. Stand for 5-10 minutes.
6	Wholemeal Macaroni	250	Use a large glass ovenware dish with lid. Add 1 L hot boiling water, a pinch of salt and stir well. Cook uncovered. Stir before standing time and drain thoroughly afterwards. Stand for 1-3 minutes.
7	Fresh Fish Fillets	300	Rinse fish and put on a ceramic plate, add 1 tbsp lemon juice. Cover with microwave cling film. Pierce film. Put dish on turntable. Stand for 1-2 minutes.
8	Fresh Salmon Fillets	300	Rinse fish and put on a ceramic plate, add 1 tbsp lemon juice. Cover with microwave cling film. Pierce film. Put dish on turntable. Stand for 1-2 minutes.
9	Fresh Prawns	250	Rinse prawns on a ceramic plate, add 1 tbsp lemon juice. Cover with microwave cling film. Pierce film. Put dish on turntable. Stand for 1-2 minutes.

Operations

2. Meat/Poultry

Code	Food	Serving Size (g)	Instructions
1	Chicken Breasts	300	Rinse pieces and put on a ceramic plate. Cover with microwave cling film. Pierce film. Put dish on turntable. Stand for 2 minutes.
2	Turkey Breasts	300	Rinse pieces and put on a ceramic plate. Cover with microwave cling film. Pierce film. Put dish on turntable. Stand for 2 minutes.
3	Meatballs	1 Sr	<p>Ingredients For Meat Balls. 450 g ground beef, ¼ cup chopped onion, 1 egg beaten, 1 teaspoon salt, ¼ teaspoon pepper and 2 tablespoons water. Combine all ingredients and mix well.</p> <p>Shape into 20 meat balls(each Ø25 mm). Place meat balls in utensil. Cover with microwave cling wrap turning back one corner of the wrap by about 50 mm to vent. Cook. After cooking, stand meat balls for 5 minutes. Serve.</p>

Code	Food	Serving Size (g)	Instructions
4	Ham Omelet	1 Sr	<p>Ingredients for omelette. 3 med. sized eggs, 1 tomato, 30 g chopped ham, 2 tablespoons milk, herbs & Spices.</p> <p>Beat eggs, add ham, 2 tablespoons milk, herbs and spices. Cut tomato in cubes add to mix plus 50 g grated cheese. After oven beeps, stir well and press start to continue. After cooking stand for 2min. Serve.</p>
5	Bacon	1 serving	Put bacon on a microwave-safe plate and put plate in centre of turntable.
6	Bacon	2 servings	
7	Bacon	3 servings	

3.Snack

For inexperienced cooks, the oven offers a total of 14 Auto Cook programmes in Snack button. Take advantage of this feature to save you time or shorten your learning curve. The cooking time and temperature will be adjusted according to the selected recipe.

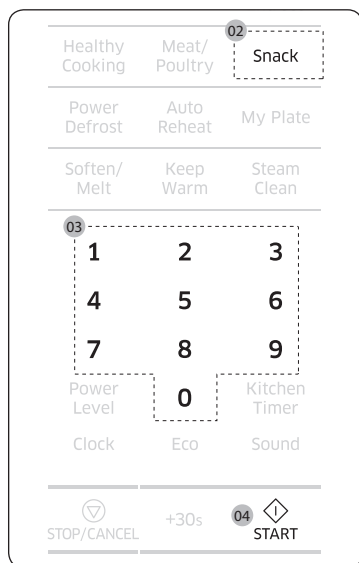
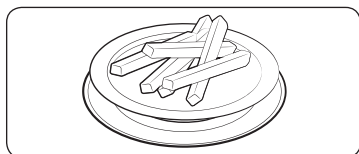

1. Put food in a microwave-safe container and then in the centre of the turntable.
2. Select a category by pressing the **Snack** button.
3. Use the selected button again or the number buttons to select a specific programme.
4. Press **START**.
5. When cooking is complete with a beep 4 times, use oven gloves to take out the food.

Auto cook guide

The following table presents auto programmes for cooking, roasting, and baking. The table contains food quantities, weight ranges, and appropriate recommendations. Cooking modes and times have been pre-programmed for your convenience.

1. Snack

Code	Food	Serving Size (g)	Instructions
1	Frozen Chicken wings	170-200	Place wings around plate, spoke-fashion. Cover with wax paper.
2	Frozen Chicken wings	230-260	
3	Frozen Chicken nuggets	110-140	Put a paper on top of plate and arrange nuggets in spoke fashion on paper towel. Do not cover. Let stand 1 min.
4	Frozen Chicken nuggets	170-200	
5	Frozen French Fries	110-140	Place two paper towels on a microwave-safe plate and arrange the French fries on the towels without letting them overlap. Blot the fries with additional paper towels after removing from the oven. Stand for 1-2 minutes.
6	Frozen French Fries	170-200	
7	Frozen Cheese sticks	5-6 pc	Place the cheese sticks on a plate in a spoke-like fashion. Do not cover Stand for 1-2 minutes.
8	Frozen Cheese sticks	7-10 pc	

Operations

Code	Food	Serving Size (g)	Instructions
9	Nacho		Place the nachos on a plate without letting them overlap. Sprinkle cheese evenly over them. Contents: 2 cups tortilla chips ½ cup grated cheese
10	Quiche (Chilled)		This program is suitable for refrigerated quiche. Remove a package and put on the dish. Place on turntable in oven. After cooking, stand for 1-2 minutes.
11	Porridge	1 serving	Place dry porridge oats and water or milk in a microwave safe bowl. Add 150 ml water or milk for 35 g and 300 ml water or milk for 70 g. Cook uncovered. After oven beeps, stir the oats well and press start to continue. After cooking, stir well and top with brown sugar or honey.
12	Porridge	2 servings	
13	Potato wedges	300-350	Wash normal sized potatoes and cut them into wedges. Brush with olive oil and spices. Place them with the cut side on the microwave safe plate. Stand for 1-2 minutes.
14	Potato wedges	400-450	

Convenience

Soften/Melt

This is useful to soften or melt soft food or confection such as butter, chocolate, and sugar.

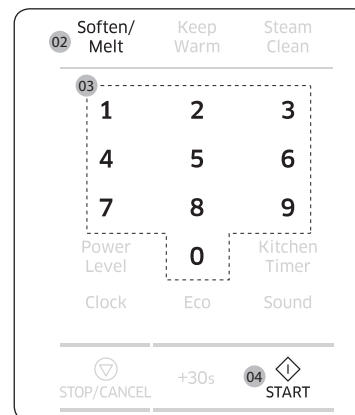

1. Put food in the centre of the turntable.
2. Press **Soften/Melt**.
3. Use the Soften/Melt button again or the number buttons to select a specific programme.
4. Press **START**.
5. When the cycle is complete with a beep 4 times, use oven gloves to take out the food.

Soften/Melt guide

The following table presents auto programmes for softening or melting specific kinds of food. The table contains food quantities, weight ranges, and appropriate recommendations.

Code	Food	Serving Size (g)	Instructions
1	Melt Butter	50	Cut butter into 3 or 4 pieces and Put them on small glass bowl. Melt uncovered. Stir after cooking. Stand for 1-2 minutes.
2	Melt Butter	100	
3	Melt Dark Chocolate	50	Grate dark chocolate and put in small glass bowl. Melt uncovered. Stir after melting. Stand for 1-2 minutes.
4	Melt Dark Chocolate	100	
5	Melt Sugar	25	Put sugar on small glass bowl. Add 10 ml water for 25 g and add 20 ml water for 50 g. Melt uncovered. Take out carefully, use oven gloves! Use spoon or fork and pour caramel decorations on baking paper. Let stand for 10 minutes until dry and remove from paper.
6	Melt Sugar	50	
7	Soften Butter	50	Cut butter into 3 or 4 pieces and Put them in small glass bowl. Soften uncovered. Stand for 1-2 minutes.
8	Soften Butter	100	

Auto Reheat

Use Auto Reheat to warm up food leftovers or precooked food. The operating time and power level will be set according to the selected programme.

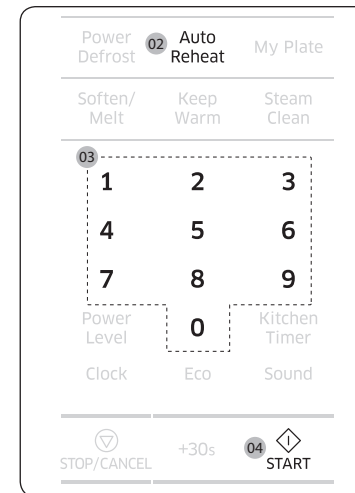

1. Put food in the centre of the turntable and close the door.
2. Press **Auto Reheat**.
3. Use the Auto Reheat button again or the number buttons to select a specific programme.
4. Press **START**.
5. When the cycle is complete with a beep 4 times, use oven gloves to take out the food.

Operations

Auto Reheat guide

The following table presents auto programmes for reheating food. The table contains food quantities, weight ranges, and appropriate recommendations.

Code	Food	Serving Size (g)	Instructions
1	Casserole / Stew	1 serving 200-230	Place refrigerated casserole in glass bowl. Cover the plate with a lid or vented plastic wrap. After cooking, stir the food once before serving. Stand for 1-2 minutes.
2	Casserole/Stew	2 servings 400-450	
3	Casserole / Stew	3 servings 600-690	
4	Casserole / Stew	4 servings 800-920	
5	Pasta / Soup	1 serving 200-230	Pour into a deep ceramic soup plate or bowl and cover during heating and standing. Stir carefully before and after standing time. Stand for 2-3 minutes.
6	Pasta / Soup	2 servings 400-450	
7	Pasta / Soup	3 servings 600-690	
8	Pasta / Soup	4 servings 800-920	
9	Pizza Reheat	1 Slice	Place pizza slices on a microwave-safe plate with the wide ends of the slices towards the outside edge of the plate. Do not let the slices overlap. Do not cover.
10	Pizza Reheat	2 Slices	
11	Pizza Reheat	3 Slices	
12	Pizza Reheat	4 Slices	

My plate

The **My plate** features has 4 pre-programmed cooking times. you do not need to set either the cooking times or the power level.

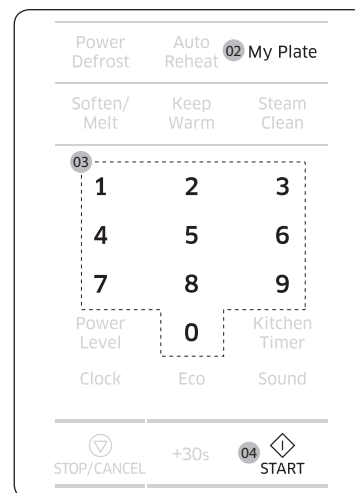

1. Put food in the centre of the turntable and close the door.
2. Press **My plate**.
3. Use the **My plate** button again or the number buttons to select a specific programme.
4. Press **START**.
5. When the cycle is complete with a beep 4 times, use oven gloves to take out the food.

My plate guide

The following table presents the **My plate** auto reheat programmes, quantities and appropriate instructions. Those programmes are running with microwave energy only.

Code	Food	Serving Size (g)	Instructions
1	Chilled Ready Meal	300-350	Put on a ceramic plate and cover with microwave cling film. This programme is suitable for meals consisting of 3 components (e.g. meat with sauce, vegetables and a side dishes like potatoes, rice or pasta). Stand for 2-3 minutes.
2	Chilled Ready Meal	400-450	Put meal on a ceramic plate and cover with microwave cling film. This programme is suitable for meals consisting of 2 components (e.g. spaghetti with sauce or rice with vegetables). Stand for 2-3 minutes.
3	Chilled Vegetarian Meal	300-350	Put meal on a ceramic plate and cover with microwave cling film. This programme is suitable for meals consisting of 2 components (e.g. spaghetti with sauce or rice with vegetables). Stand for 2-3 minutes.
4	Chilled Vegetarian Meal	400-450	Put meal on a ceramic plate and cover with microwave cling film. This programme is suitable for meals consisting of 2 components (e.g. spaghetti with sauce or rice with vegetables). Stand for 2-3 minutes.

Power Defrost

This is useful to defrost frozen meat, poultry, fish, or bread/cake. The operating time and power level will be adjusted according to the selected programme.

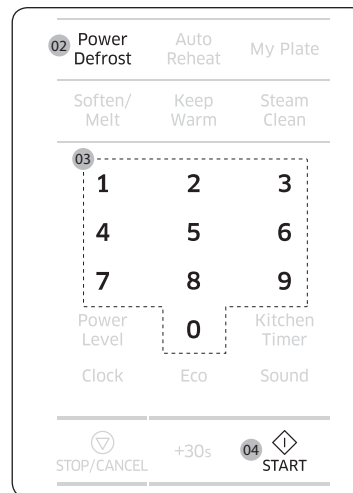

1. Put food in the centre of the turntable and close the door.
2. Press **Power Defrost** to select category.
3. Use the number buttons to select a weight.
4. Press **START**.
5. When the cycle is complete with a beep 4 times, use oven gloves to take out the food.

NOTE

- The oven beeps in the middle of the cycle to remind you to turn the food over. Turn the food over, and press Start again to continue. When the cycle is complete, the oven beeps 4 times.
- You can defrost food manually. To do this, use a cooking mode with just 20 % of the default power level of the cooking mode. For more information, see the Power level section.

Operations

Power Defrost guide

The following table presents auto programmes for defrosting food. The table contains food quantities, weight ranges, and appropriate recommendations.

Code	Food	Serving Size (kg)	Instructions
1	Meat	0.1-1.5	Shield the edges with aluminium foil. Turn the meat over, when the oven beeps. This programme is suitable for beef, lamb, pork, steaks, chops, minced meat. Stand for 10-30 minutes.
2	Poultry	0.1-1.5	This program is suitable for whole chicken as well as for chicken pieces. Before defrosting, if a lot of ice crystals are present on poultry surface, it should be rinsed under cold water until all the ice crystals are removed. The poultry should then be left to stand for 5 to 10 min. at room temperature. Shield the leg and wing tips with aluminum foil. Place chicken pieces skin-side down, and whole chicken breast-side down on the middle of a flat microwave-safe plate. Turn the poultry over when the oven beeps
3	Fish	0.1-1.5	Shield the tail of a whole fish with aluminium foil. Turn the fish over, when the oven beeps. This programme is suitable for whole fishes as well as for fish fillets. Stand for 10-30 minutes.
4	Bread / Cake	0.1-1.0	Put bread on a piece of kitchen paper and turn over, as soon as the oven beeps. Place cake on a ceramic plate and if possible, turn over, as soon as the oven beeps. (Oven keeps operating and is stopped, when you open the door.) This programme is suitable for all kinds of bread, sliced or whole, as well as for bread rolls and baguettes. Arrange bread rolls in a circle. This programme is suitable for all kinds of yeast cake, biscuit, cheese cake and puff pastry. It is not suitable for short/crust pastry, fruit and cream cakes as well as for cake with chocolate topping. Stand for 5-30 minutes.

Keep warm

The **Keep warm** feature keeps food hot until it's served. Use this function to keep food warm until ready to serve. Keep warm mode operates for 99 minute.

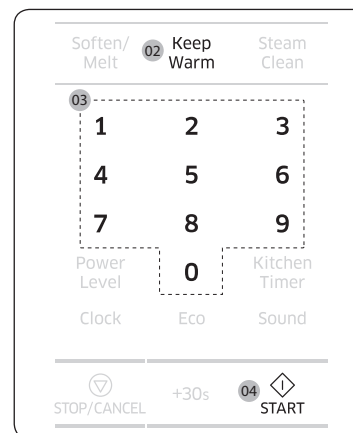

1. Put food in the centre of the turntable and close the door.
2. Press **Keep warm**.
3. Press the **number** buttons if you want to set the warming time. (Warming time is set as 99 minute at first)
4. Press **START**.
To stop warming the food, open the door or press **STOP/CANCEL** button.
5. When the cycle is complete with a beep 4 times, use oven gloves to take out the food.

IMPORTANT

Do not cover with lids or plastic wrap.

IMPORTANT

Use oven gloves when taking out food.

IMPORTANT

Do not use this function to reheat cold foods. This programmes are for keeping food warm that has just been cooked.

IMPORTANT

Do not recommend food being kept warm for too long (more than 1 hour), as it will continue to cook. Warm food spoils more quickly.

Steam clean

The steam provided by steam clean system will soak the cavity surface. After using steam clean function, you can easily clean the cavity of oven.

IMPORTANT

Use this function only after the oven has completely cooled. (Room temperature)

NOTE

Use normal water only, and no distilled water.

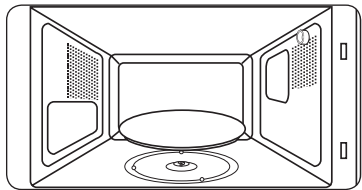

1. Open the Door.

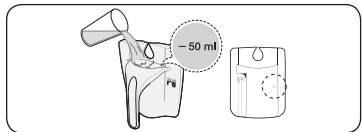

2. Fill with water following guide line (water level) outside the water bowl. (The line is about 50 ml.)

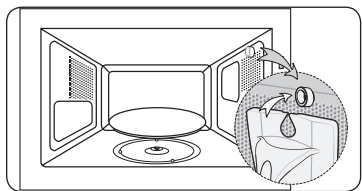

3. Insert water bowl into upper water bowl holder on the right wall of cooking chamber. At that time close the door.

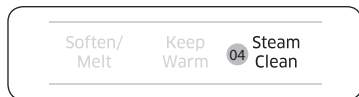

4. Press the **Steam Clean** button, and press the **START** button. It can be seen **MISTY** during steam cleaning, but it is not a defect **BUT STEAM SHIELDS THE light INSIDE.**

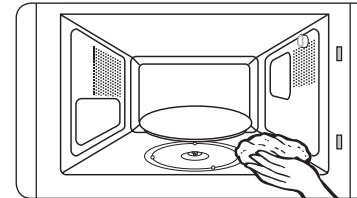
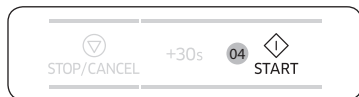

5. Open the door and please clean cavity of oven with dried dishtowel. Remove the turntable and only under rack with kitchen paper.

WARNING

Water Bowl only can be use during “**Steam Clean**” mode.

When cooking non-liquid items, remove water bowl because It will damage and cause fire to the microwave oven.

NOTE

More than 50 ml water may cause a leak at the back through the hole. Ensure that it is not more than 50 ml.

Cooking Smart

We provide these cooking guides to help you make the most out of this oven. Experience our cooking know-how to add convenience and richness to your life.

Microwave cooking guide

- Cover the food throughout the entire cooking. The vaporised moisture from the food circles through inside and helps cook evenly.
- When cooking is complete, let stand for the specified time. This allows the food to even out inside.
- Use only microwave-safe cookware.

Frozen vegetables

- Use a suitable glass Pyrex container with a lid.
- Stir twice during cooking and once after cooking, and then add seasoning to your preference.

Food	Serving Size (g)	Power	Time (min.)
Spinach	150	60 %	5-6
	Add 15 ml (1 tbsp) cold water. Stand for 2-3 minutes.		
Broccoli	300	60 %	8-9
	Add 30 ml (2 tbsp) cold water. Stand for 2-3 minutes.		
Peas	300	60 %	7-8
	Add 15 ml (1 tbsp) cold water. Stand for 2-3 minutes.		
Green Beans	300	60 %	7½-8½
	Add 30 ml (2 tbsp) cold water. Stand for 2-3 minutes.		
Mixed Vegetables (Carrots/Peas/Corn)	300	60 %	7-8
	Add 15 ml (1 tbsp) cold water. Stand for 2-3 minutes.		
Mixed Vegetables (Chinese style)	300	60 %	7½-8½
	Add 15 ml (1 tbsp) cold water. Stand for 2-3 minutes.		

Fresh vegetables

- Use a suitable glass Pyrex container with a lid.
- Cut ingredients into as small pieces as possible to reduce the cooking time.
- Add 30-45 ml of cold water to every 250 g unless otherwise specified.
- Stir once during cooking and once after cooking, and then add seasoning to your preference.

Food	Serving Size (g)	Power	Time (min.)
Broccoli	250	90 %	4½-5 7-8
	500		
Prepare even sized florets. Arrange the stems to the centre. Stand for 3 minutes.			
Brussels Sprouts	250	90 %	6-6½
	Add 60-75 ml (4-5 tbsp) water. Stand for 3 minutes.		
Carrots	250	90 %	4½-5
	Cut carrots into even sized slices. Stand for 3 minutes.		
Cauliflower	250	90 %	5-5½ 7½-8½
	500		
Prepare even sized florets. Cut big florets into halves. Arrange stems to the centre. Stand for 3 minutes.			
Courgettes	250	90 %	4-4½
	Cut courgettes into slices. Add 30 ml (2 tbsp) water or a knob of butter. Cook until just tender. Stand for 3 minutes.		
Egg plants	250	90 %	3½-4
	Cut egg plants into small slices and sprinkle with 1 tbsp lemon juice. Stand for 3 minutes.		
Leeks	250	90 %	4-4½
	Cut leeks into thick slices. Stand for 3 minutes.		

Food	Serving Size (g)	Power	Time (min.)
Mushrooms	125	90 %	1½-2
	250		2½-3
Prepare small whole or sliced mushrooms. Do not add any water. Sprinkle with lemon juice. Spice with salt and pepper. Drain before serving. Stand for 3 minutes.			
Onions	250	90 %	5-5½
	Cut onions into slices or halves. Add only 15 ml (1 tbs) water. Stand for 3 minutes.		
Pepper	250	90 %	4½-5
	Cut pepper into small slices. Stand for 3 minutes.		
Potatoes	250	90 %	4-5
	500		7-8
Weigh the peeled potatoes and cut them into similar sized halves or quarters. Stand for 3 minutes.			
Turnip Cabbage	250	90 %	5½-6
	Cut turnip cabbage into small cubes. Stand for 3 minutes.		

Rice and pasta

Rice

- Use a large-sized glass Pyrex container with a lid. Note that rice doubles in volume during cooking.

Pasta

- Use a large-sized glass Pyrex container. Cook uncovered.
- Add boiling water and a little salt, and stir well. Stir several times during and after cooking.
- Cover with a lid while letting stand, and then drain well.

Food	Serving Size	Power	Time (min.)
White Rice (Parboiled)	250 g	90 %	15-16
	375 g		17½-18½
Add 500 ml cold water.(250 g), Add 750 ml cold water. (375 g) Stand for 5 minutes.			
Brown Rice (Parboiled)	250 g	90 %	20-21
	375 g		22-23
Add 500 ml cold water.(250 g), Add 750 ml cold water. (375 g) Stand for 5 minutes.			
Mixed Rice (Rice + Wild Rice)	250 g	90 %	16-17
	Add 500 ml cold water. Stand for 5 minutes.		
Mixed Corn (Rice + Grain)	250 g	90 %	17-18
	Add 400 ml cold water. Stand for 5 minutes.		
Pasta	250 g	90 %	10-11
	Add 1000 ml hot water. Stand for 5 minutes.		

Cooking Smart

Reheating guide

General

This reheating guide is based on the condition that the room temperature is between 18 °C and 20 °C for liquid, and between 5 °C and 7 °C for chilled food. Follow the operating time, power level, and standing time specified in this table.

Food	Serving Size (g)	Power	Time (min.)
Drinks (Coffee, Tea and Water)	150 ml (1 cup)	90 %	1-1½
	300 ml (2 cups)		2-2½
	450 ml (3 cups)		3-3½
	600 ml (4 cups)		3½-4
	Pour into cups and reheat uncovered: 1 cup in the centre, 2 cups opposite of each other, 3 cups in a circle. Keep in microwave oven during standing time and stir well. Stand for 1-2 minutes.		
Soup (Chilled)	250 g	90 %	2½-3
	350 g		3-3½
	450 g		3½-4
	550 g		4½-5
	Pour into a deep ceramic plate or deep ceramic bowl. Cover with plastic lid. Stir well after reheating. Stir again before serving. Stand for 2-3 minutes.		
Stew (Chilled)	350	60 %	4½-5½
	Put stew in a deep ceramic plate. Cover with plastic lid. Stir occasionally during reheating and again before standing and serving. Stand for 2-3 minutes.		
Pasta with Sauce (Chilled)	350	60 %	3½-4½
	Put pasta (e.g. spaghetti or egg noodles) on a flat ceramic plate. Cover with microwave cling film. Stir before serving. Stand for 3 minutes.		

Food	Serving Size (g)	Power	Time (min.)
Filled Pasta with Sauce (Chilled)	350	60 %	4-5
	Put filled pasta (e.g. ravioli, tortellini) in a deep ceramic plate. Cover with plastic lid. Stir occasionally during reheating and again before standing and serving. Stand for 3 minutes.		
Plated Meal (Chilled)	350	60 %	4½-5
	450		5½-6½
Plate a meal of 2-3 chilled components on a ceramic dish. Cover with microwave cling-film. Stand for 3 minutes.			
Cheese Fondue Ready-to-Serve (Chilled)	400	60 %	6-7
	Put the ready-to-serve cheese fondue in a suitable sized glass pyrex bowl with lid. Stir occasionally during and after reheating. Stir well before serving. Stand for 1-2 minutes.		

Special care for baby food

To prevent accidents such as burns, special care must be taken for baby food before serving. Make sure to strictly follow this reheating guide for baby food.

Baby food

- Use a deep ceramic plate and cover it with a plastic lid.
- Recommended serving temperature is 30-40 °C.

Baby milk

- Use a sterilised glass bottle and reheat it uncovered.
- Remove the teat before reheating. Otherwise, the milk in the bottle boils over.

Food	Serving Size	Power	Time (sec.)
Baby Food (Vegetables + Meat)	190 g	60 %	30
	Empty into ceramic deep plate. Cook covered. Stir after cooking time. Before serving, stir well and check the temperature carefully. Stand for 2-3 minutes.		
Baby Porridge (Grain + Milk + Fruit)	190 g	60 %	20
	Empty into ceramic deep plate. Cook covered. Stir after cooking time. Before serving, stir well and check the temperature carefully. Stand for 2-3 minutes.		
Baby Milk	100 ml	30 %	30-40
	200 ml		60-70
Stir or shake well and pour into a sterilised glass bottle. Place into the centre of turn-table. Cook uncovered. Shake well and stand for at least 3 minutes. Before serving, shake well and check the temperature carefully.			

Defrosting guide

This defrosting guide is based on the condition that frozen food is between -18 °C and -20 °C in internal temperatures. The standing time varies depending on the food type (meat or vegetables) and serving size (thinner or thicker pieces of food).

- Put frozen food in a microwave-safe container uncovered.
- Turn it over halfway through defrosting time and drain well when complete.

	Food	Serving Size	Power	Time (min.)
Meat	Minced Meat	250 g	20 %	6-7
		500 g		8-13
	Pork Steaks	250 g		7-8
Place the meat on turntable. Shield thinner edges with aluminium foil. Turn over after half of defrosting time! Stand for 15-30 minutes.				
Poultry	Chicken Pieces	500 g (2 pcs)	20 %	14-15
	Whole Chicken	1200 g		32-34
First, put chicken pieces first skin-side down, whole chicken first breast-side-down on a flat ceramic plate. Shield the thinner parts like wings and ends with aluminium foil. Turn over after half of defrosting time! Stand for 15-60 minutes.				
Fish	Fish Fillets	200 g	20 %	6-7
	Whole Fish	400 g		11-13
Put frozen fish in the middle of a flat ceramic plate. Arrange the thinner parts under the thicker parts. Shield narrow ends of fillets and tail of whole fish with aluminium foil. Turn over after half of defrosting time! Stand for 10-25 minutes.				
Fruits	Berries	300 g	20 %	6-7

Cooking Smart

	Food	Serving Size	Power	Time (min.)
Bread	Bread Rolls (Each ca. 50 g)	2 pcs	20 %	1-1½
		4 pcs		2½-3
	Toast/Sandwich	250 g		4-4½
	German Bread (Wheat + Rye Flour)	500 g		7 - 9
Arrange rolls in a circle or bread horizontally on kitchen paper in the middle of turntable. Turn over after half of defrosting time! Stand for 5-20 minutes.				

Quick & Easy

Melting crystallized honey

Put 20 g crystallized honey into a small deep glass dish. Heat for 20-30 seconds using 30 %, until honey is melted.

Melting gelatine

Lay dry gelatine sheets (10 g) for 5 minutes into cold water. Put drained gelatine into a small glass pyrex bowl. Heat for 1 minute using 30 %. Stir after melting.

Cooking glaze/icing (for cake and gateaux)

Mix instant glaze (approximately 14 g) with 40 g sugar and 250 ml cold water. Cook uncovered in a glass pyrex bowl for 3½ to 4½ minutes using 90 %, until glaze/icing is transparent. Stir twice during cooking.

Cooking jam

Put 600 g fruits (for example mixed berries) in a suitable sized glass pyrex bowl with lid. Add 300 g preserving sugar and stir well. Cook covered for 10-12 minutes using 90 %. Stir several times during cooking. Empty directly into small jam glasses with twist-off lids. Stand on lid for 5 minutes.

Cooking pudding/ custard

Mix pudding powder with sugar and milk (500 ml) by following the manufacturers instructions and stir well. Use a suitable sized glass pyrex bowl with lid. Cook covered for 6½ to 7½ minutes using 90 %. Stir several times well during cooking.

Browning almond slices

Spread 30 g sliced almonds evenly on a medium sized ceramic plate. Stir several times during browning for 3½ to 4½ minutes using 60 %. Let it stand for 2-3 minutes in the oven. Use oven gloves while taking out!

Troubleshooting and information code

Troubleshooting

If you have any of the problems listed below try the solutions given.

Problem	Cause	Action
General		
The buttons cannot be pressed properly.	Foreign matter may be caught between the buttons.	Remove the foreign matter and try again.
	For touch models: Moisture is on the exterior.	Wipe the moisture from the exterior.
	Child lock is activated.	Deactivate Child lock.
The time is not displayed.	The Eco (power-saving) function is set.	Turn off the Eco function.
The oven does not work.	Power is not supplied.	Make sure power is supplied.
	The door is open.	Close the door and try again.
	The door open safety mechanisms are covered in foreign matter.	Remove the foreign matter and try again.
The oven stops while in operation.	The user has opened the door to turn food over.	After turning over the food, press the Start button again to start operation.

Problem	Cause	Action
The power turns off during operation.	The oven has been cooking for an extended period of time.	After cooking for an extended period of time, let the oven cool.
	The cooling fan is not working.	Listen for the sound of the cooling fan.
	Trying to operate the oven without food inside.	Put food in the oven.
	There is not sufficient ventilation space for the oven.	There are intake/exhaust outlets on the front and rear of the oven for ventilation. Keep the gaps specified in the product installation guide.
	Several power plugs are being used in the same socket.	Designate only one socket to be used for the oven.
There is a popping sound during operation, and the oven doesn't work.	Cooking sealed food or using a container with a lid may causes popping sounds.	Do not use sealed containers as they may burst during cooking due to expansion of the contents.
The oven exterior is too hot during operation.	There is not sufficient ventilation space for the oven.	There are intake/exhaust outlets on the front and rear of the oven for ventilation. Keep the gaps specified in the product installation guide.
	Objects are on top of the oven.	Remove all objects on the top of the oven.
The door cannot be opened properly.	Food residue is stuck between the door and oven interior.	Clean the oven and then open the door.

Troubleshooting and information code

Problem	Cause	Action
Heating including the Warm function does not work properly.	The oven may not work, too much food is being cooked, or improper cookware is being used.	Put one cup of water in a microwave-safe container and run the microwave for 1-2 minutes to check whether the water is heated. Reduce the amount of food and start the function again. Use a cooking container with a flat bottom.
The thaw function does not work.	Too much food is being cooked.	Reduce the amount of food and start the function again.
The interior light is dim or does not turn on.	The door has been left open for a long time.	The interior light may automatically turn off when the Eco function operates. Close and reopen the door or press the Cancel button.
	The interior light is covered by foreign matter.	Clean the inside of the oven and check again.
A beeping sound occurs during cooking.	If the Auto Cook function is being used, this beeping sound means it's time to turn over the food during thawing.	After turning over the food, press the Start button again to restart operation.
The oven is not level.	The oven is installed on an uneven surface.	Make sure the oven is installed on flat, stable surface.
There are sparks during cooking.	Metal containers are used during the oven/thawing functions.	Do not use metal containers.

Problem	Cause	Action
When power is connected, the oven immediately starts to work.	The door is not properly closed.	Close the door and check again.
There is electricity coming from the oven.	The power or power socket is not properly grounded.	Make sure the power and power socket are properly grounded.
<ol style="list-style-type: none"> 1. Water drips. 2. Steam emits through a door crack. 3. Water remains in the oven. 	There may be water or steam in some cases depending on the food. This is not an oven malfunction.	Let the oven cool and then wipe with a dry dish towel.
The brightness inside the oven varies.	Brightness changes depending on power output changes according to function.	Power output changes during cooking are not malfunctions. This is not an oven malfunction.
Cooking is finished, but the cooling fan is still running.	To ventilate the oven, the cooling fan continues to run for about 3 minutes after cooking is complete.	This is not an oven malfunction.

Problem	Cause	Action
Turntable		
While turning, the turntable comes out of place or stops turning.	There is no roller ring, or the roller ring is not properly in place.	Install the roller ring and then try again.
The turn table drags while turning.	The roller ring is not properly in place, there is too much food, or the container is too large and touches the inside of the microwave.	Adjust the amount of food and do not use containers that are too large.
The turn table rattles while turning and is noisy.	Food residue is stuck to the bottom of the oven.	Remove any food residue stuck to the bottom of the oven.

NOTE

If the above guidelines do not enable you to solve the problem, then contact your local SAMSUNG customer service centre.

Please have the following information read;

- The model and serial numbers, normally printed on the rear of the oven
- Your warranty details
- A clear description of the problem

Then contact your local dealer or SAMSUNG aftersales service.

Information codes

Code	Description	Action
C-d0	Control buttons are pressed over 10 seconds.	Clean the keys and check if there is water on the surface around key. If it occurs again, turn off the microwave oven over 30 seconds and try setting again. If it appears again, call your local SAMSUNG Customer Care Centre.
C-10	Cooking sensor is needed to check.	Press the Stop/Cancel button and operate again. If it occurs again, turn off the microwave oven over 30 seconds and try setting again. If it appears again, call your local SAMSUNG Customer Care Centre.

NOTE

If the suggested solution does not solve the problem, contact your local SAMSUNG Customer Care Centre.

Technical specifications

SAMSUNG strives to improve its products at all times. Both the design specifications and these user instructions are thus subject to change without notice.

Model		MS32J5133B*	MS40J5133B*
Power Source		240 V - 50 Hz	
Power Consumption		1500 W	1550 W
Output Power		1000 W (IEC - 705)	
Operating Frequency		2450 MHz	
Magnetron		OM75P (31)	
Cooling Method		Cooling fan motor	
Dimensions (W x H x D)	Main unit	517 x 297 x 384 mm	555 x 313 x 473 mm
	Cooking chamber	357 x 255 x 357 mm	375 x 249 x 408 mm
Volume		32 L	40 L
Weight	Net	14.5 kg	17 kg

Memo

Memo

Please be advised that the Samsung warranty does NOT cover service calls to explain product operation, correct improper installation, or perform normal cleaning or maintenance.

QUESTIONS OR COMMENTS?

COUNTRY	CALL	OR VISIT US ONLINE AT
AUSTRALIA	1300 362 603	www.samsung.com/au/support
NEW ZEALAND	0800 726 786	www.samsung.com/nz/support
CHINA	400-810-5858	www.samsung.com/cn/support
HONG KONG	3698 4698	www.samsung.com/hk/support (Chinese) www.samsung.com/hk_en/support (English)
INDIA	1800 3000 8282 - Toll Free 1800 266 8282 - Toll Free	www.samsung.com/hk/support (Chinese) www.samsung.com/hk_en/support (English)
BANGLADESH	0961-2300300 0800-0300300 (Toll free)	
INDONESIA	021-56997777 08001128888	www.samsung.com/id/support
JAPAN	0120-363-905	www.samsung.com/jp/support
MALAYSIA	1800-88-9999 603-77137477 (Overseas contact)	www.samsung.com/my/support
PHILIPPINES	1-800-10-726-7864 [PLDT Toll Free] 1-800-8-726-7864 [Globe Landline and Mobile] 02- 422-2111 [Standard Landline]	www.samsung.com/ph/support
SINGAPORE	1800-SAMSUNG(726-7864)	www.samsung.com/sg/support
THAILAND	0-2689-3232, 1800-29-3232	www.samsung.com/th/support
TAIWAN	0800-329999	www.samsung.com/tw/support
VIETNAM	1800 588 889	www.samsung.com/vn/support
MACAU	0800 333	www.samsung.com/support
MYANMAR	+95-1-2399-888	
SRI LANKA	0117540540 0115900000	

DE68-04325B-01